

FABSLAB
Luxury Redefined

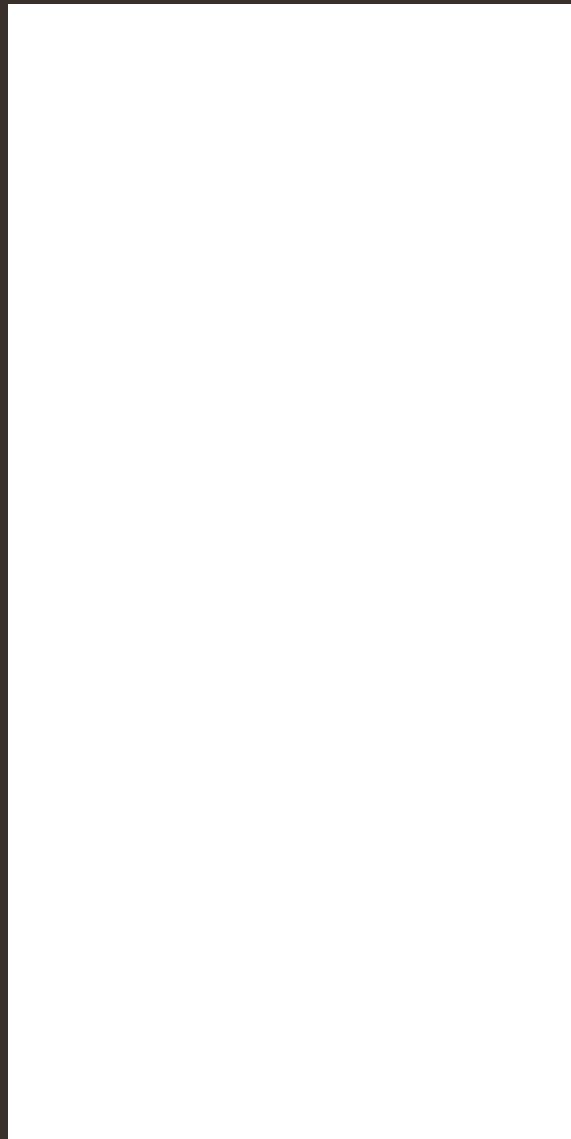

800x3000 mm
15 mm | 18 mm

www.fabslab.in

Fab Slab is a flourishing centre for Italian design and slabs. Fab Slab is a new conglomerate that offers a rich array of products and services in terms of design and manufacturing of slabs. Fab Slab represents unparalleled technical, artistic and organizational standards that distinguish it from its peers.

Fab Slab is the essence of years of rigorous research. In its core efforts, Fab Slab epitomizes the urge to establish new standards and norms in the industry. Over decades of experience has gone into the making of this ambitious venture that us set to revolutionize art and craft of manufacturing slabs. Based on ground-breaking research, Fab Slab has conceptualized its ravishing designs and world-class manufacturing process.

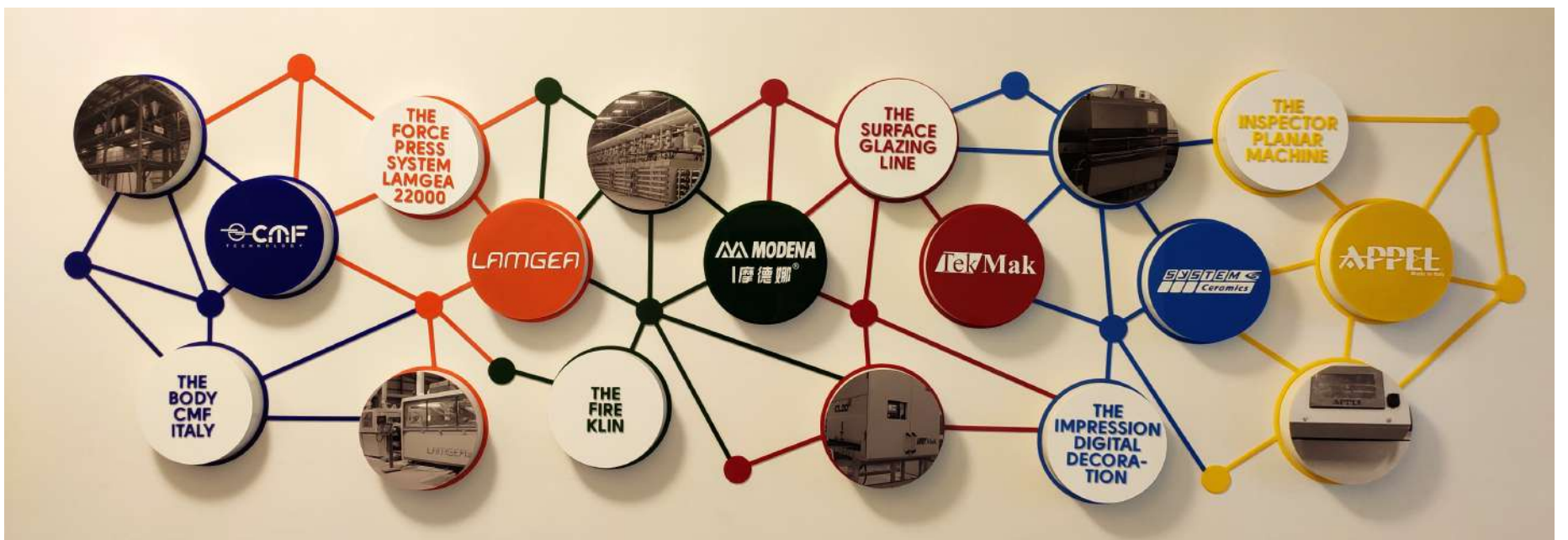

APPLICATION



AIRPORT



RESTAURANT



FITTED KITCHEN AND
BATHROOM FURNITURE



HOTELS



RETAIL MALLS



SPA AND WELLNESS
CENTRES



OFFICES



SHOPS



MUSEUMS



VENTILATED CURTAIN
WALLS



HOMES



INTERIOR DESIGN
AND FURNISHINGS

NEW PRODUCTION TECHNOLOGIES BRING UP THE CHALLENGE OF CREATING MATERIALS CAPABLE OF SHAPING THE SPACE TECHNICALLY AND ESTHETICLY IN AN EFFICIENT WAY.

Fab Slab, a brand born to provide advanced solutions to architecture and interior design. Materials that offer unlimited versatility in all fields of construction, furniture, design, etc.

FEATURES



HIGHLY UV
RESISTANT



RESISTANT TO
SCRATCHES



WATERPROOF



RESISTANCE TO
CHEMICAL ATTACK



LIGHTNESS



LIGHTNESS



FROST
RESISTANCE



RESISTANT TO
STAINS



RECYCLABLE



EASY TO CLEAN



FIREPROOF

POSSIBILITIES

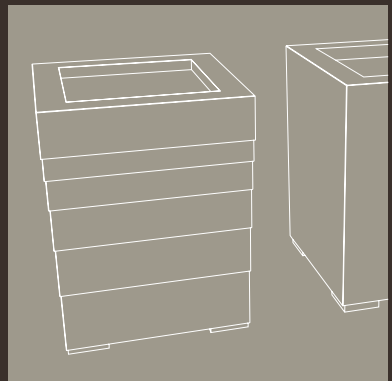
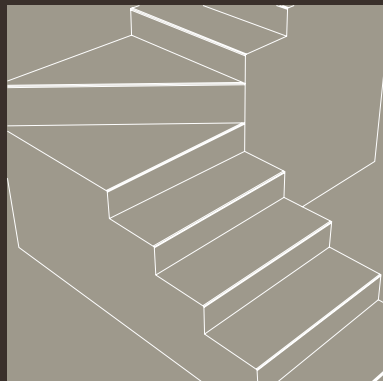
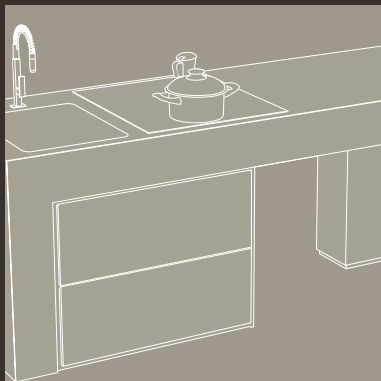
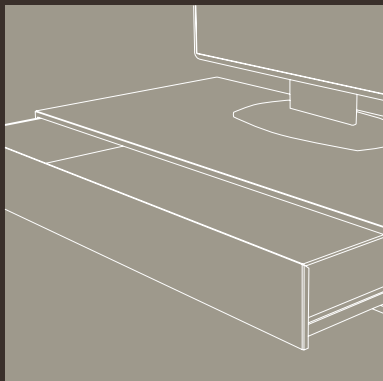
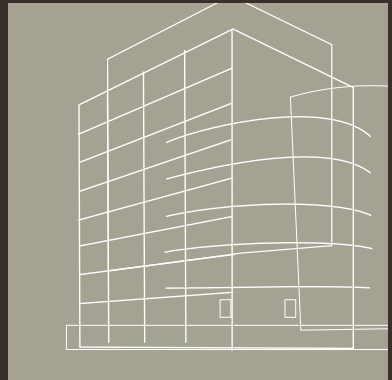
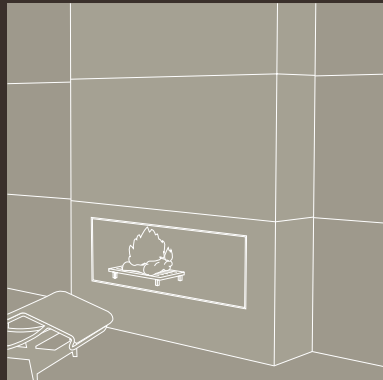
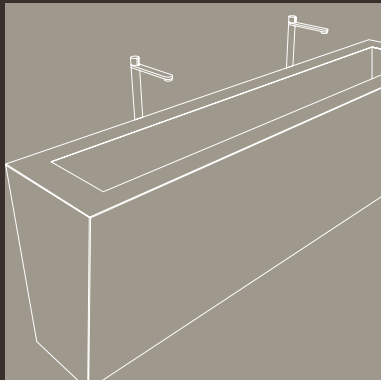
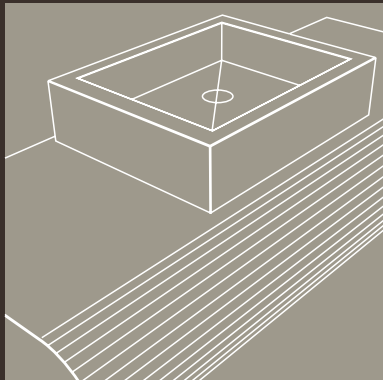
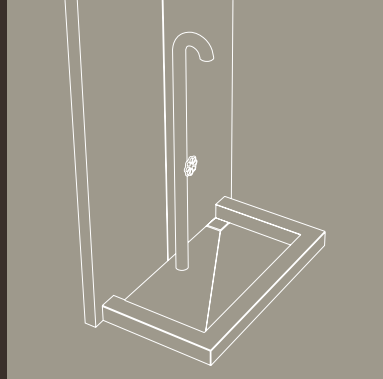
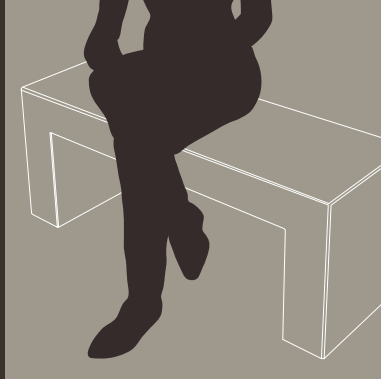
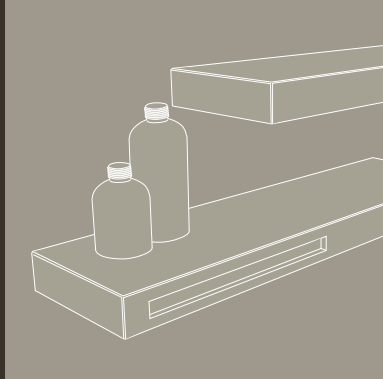

SUPER WHITE

SUPER BLACK

FABSLAB

Luxury Redefined

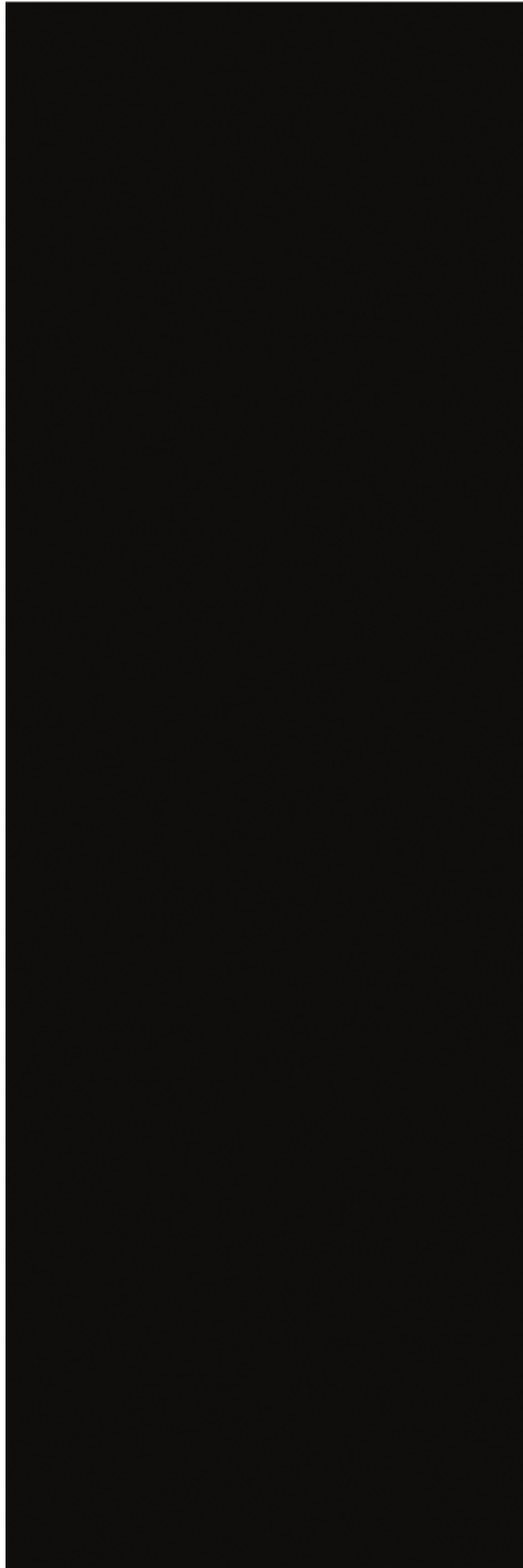
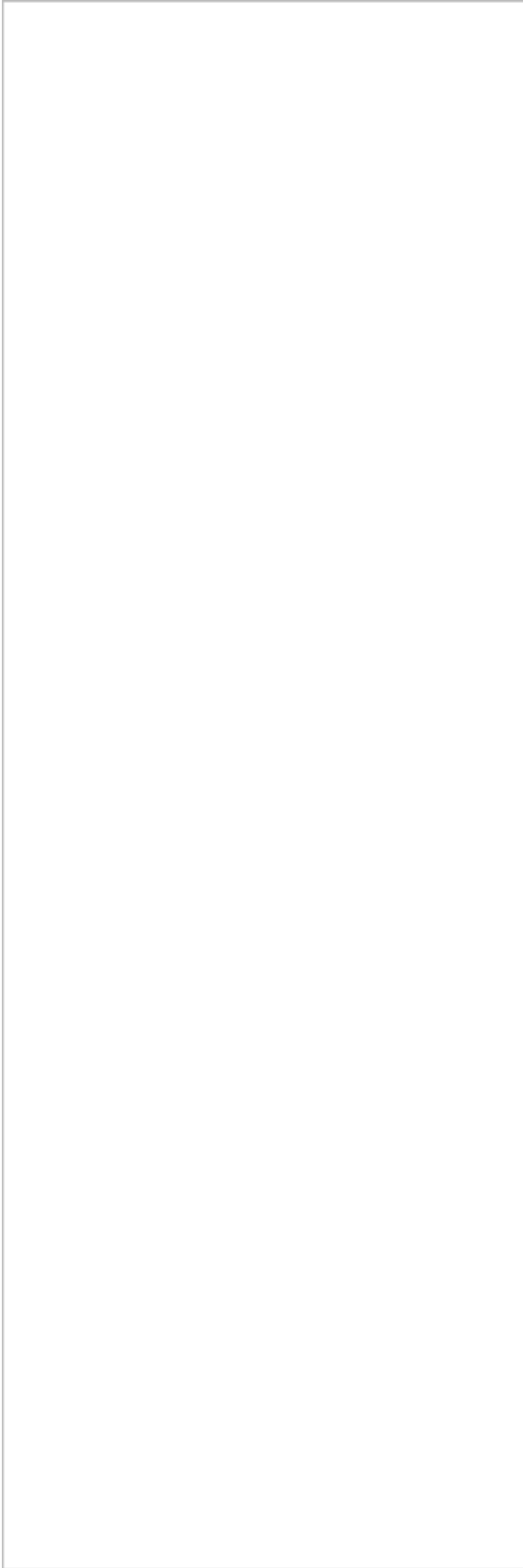

THICKNESS

15MM, 18 MM

SIZE

800X3000MM

FINISH

GLOSSY

EFFECT

MARBLE

FABSLAB
Luxury Redefined



FabSlab Granito Pvt. Ltd.

CORPORATE OFFICE

C-1226, Siddhi Vinayak Tower,
Near Kataria Arcade, Makarba,
Ahmedabad-380051, Gujarat, India.
Email: export@fabslab.in, marketing@fabslab.in
Mobile: +91 78744 93382, +91 97267 20070

PLANT

Morbi-Halwad Road,
State Highway No. 22,
Nichi Mandal,
Morbi-363641,
Gujarat, India.

www.fabslab.in